

HEA 100

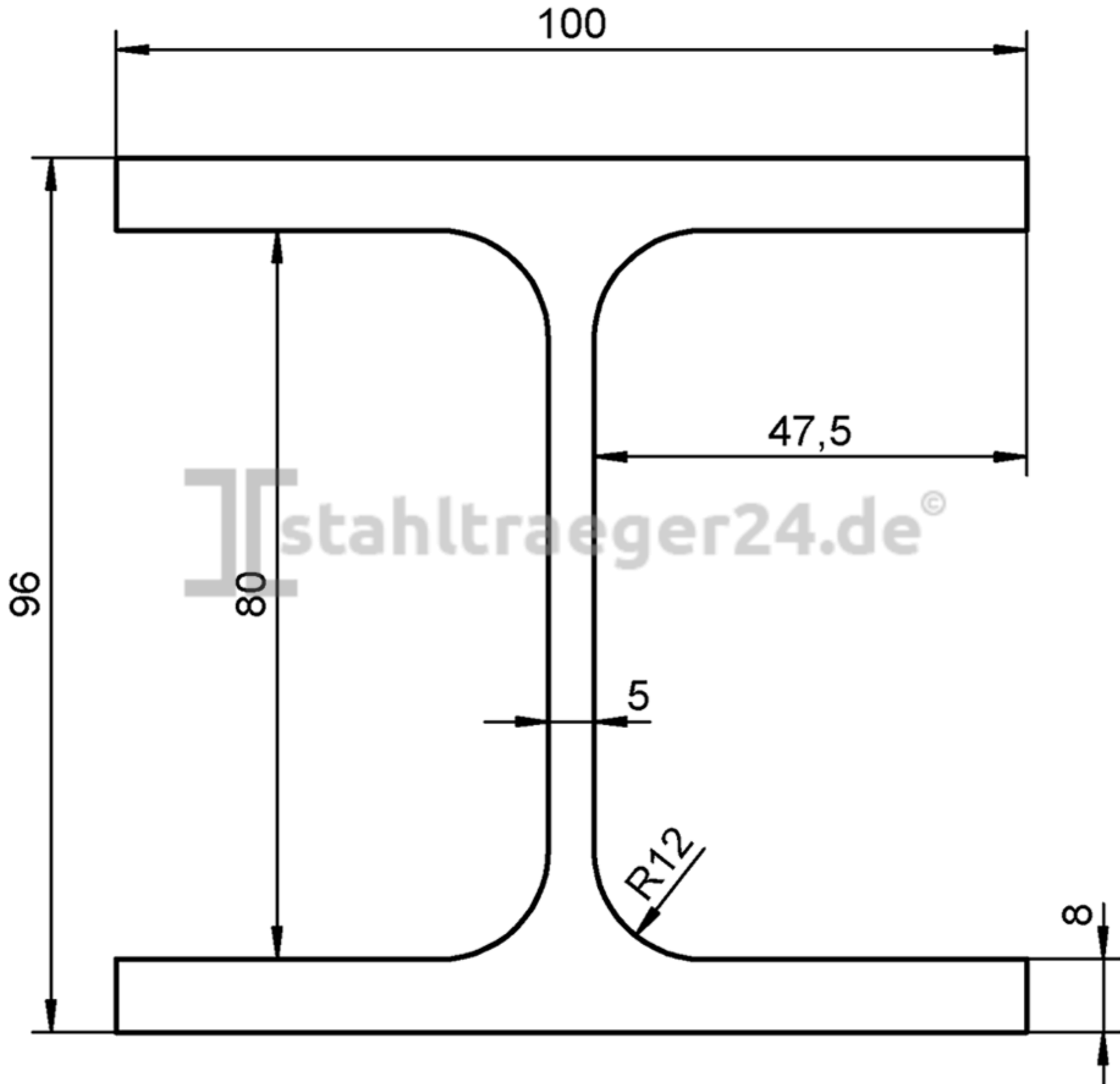

20,4 kg/m