

HEA 120

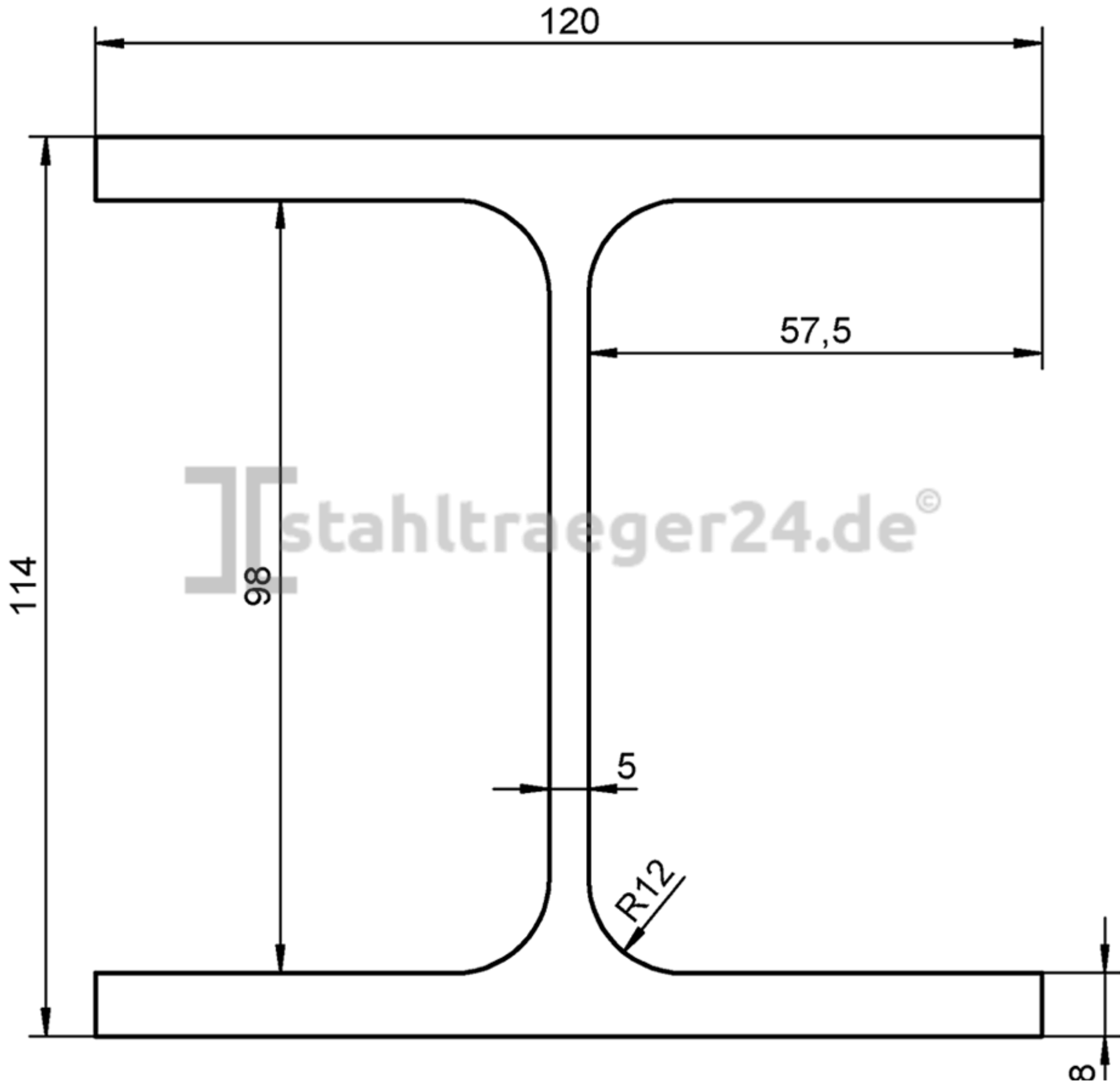

20,4 kg/m