

HEA 260

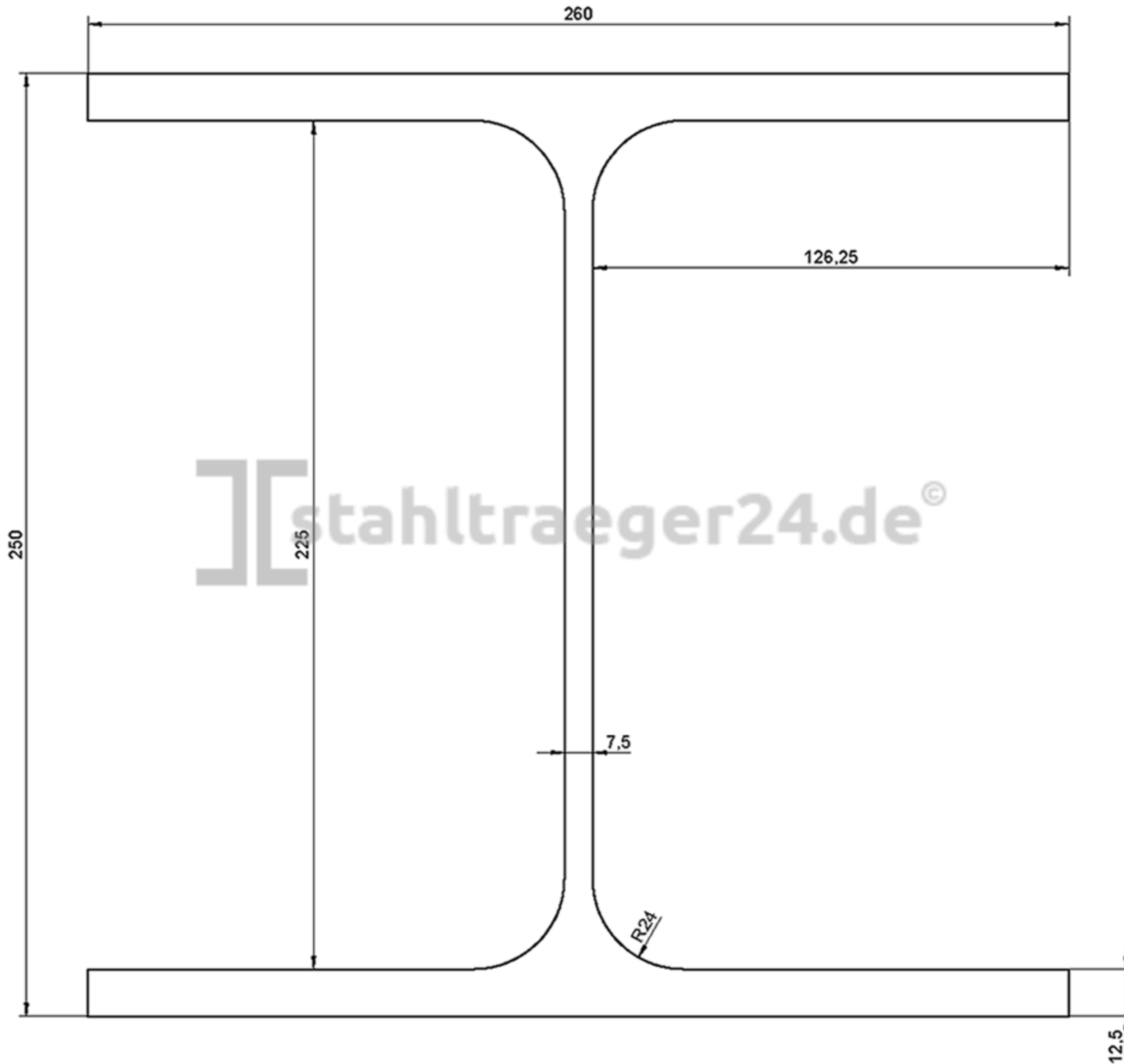

70 kg/m