

HEA 300

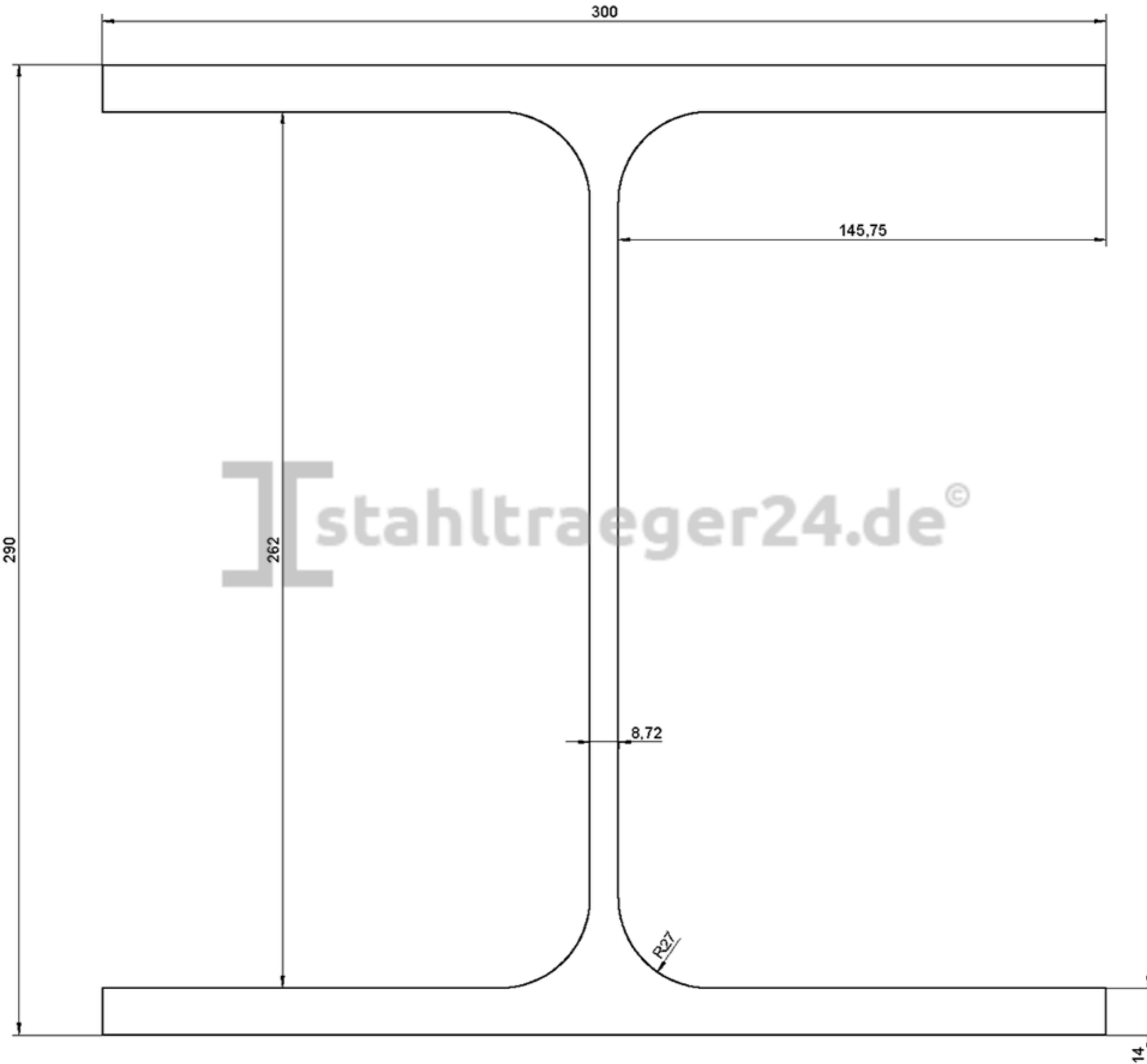

90 kg/m