

HEB 120

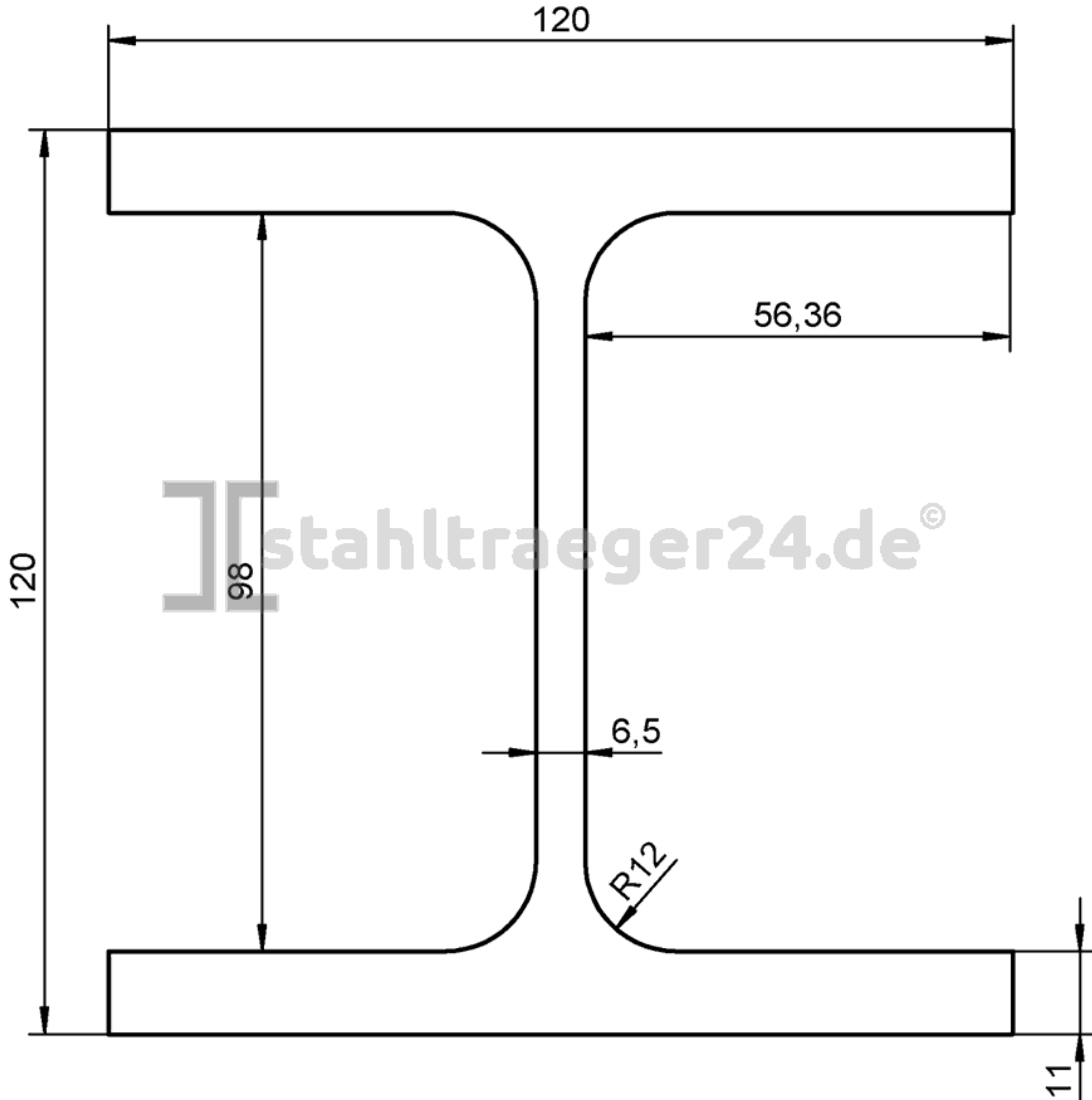

27,4 kg/m