

HEB 200

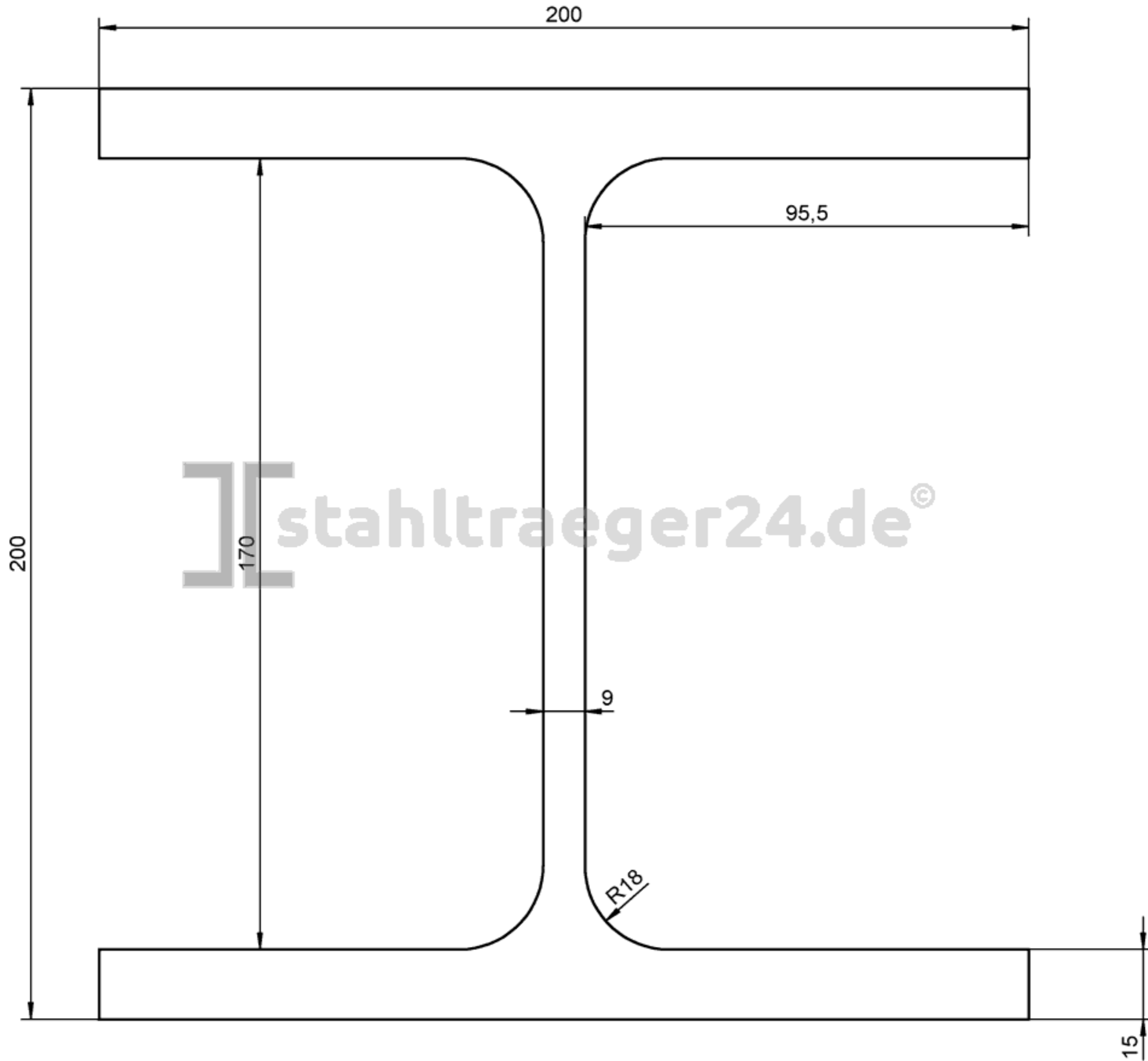

63,0 kg/m