

HEB 280

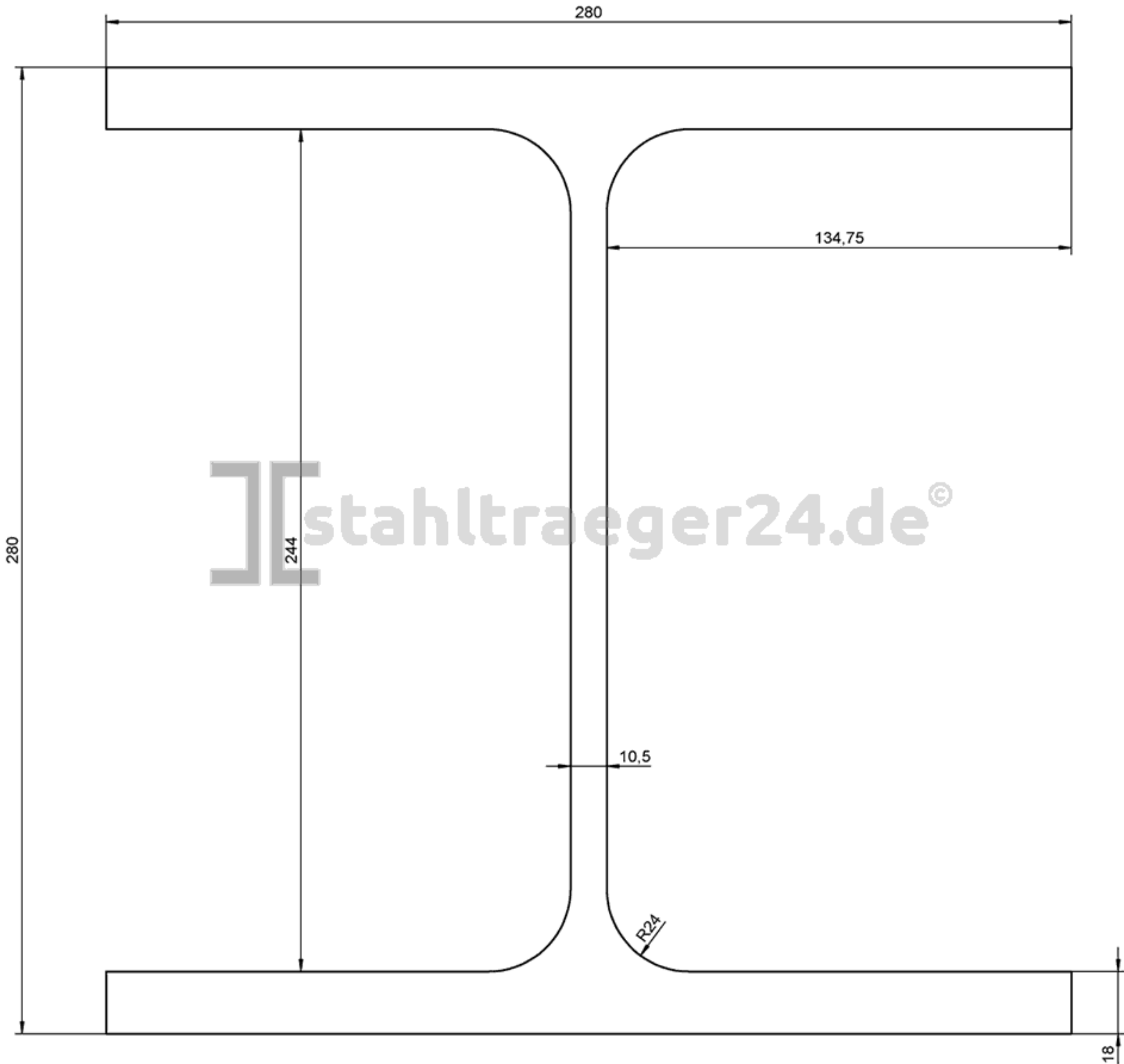

106,0 kg/m