

IPE 100

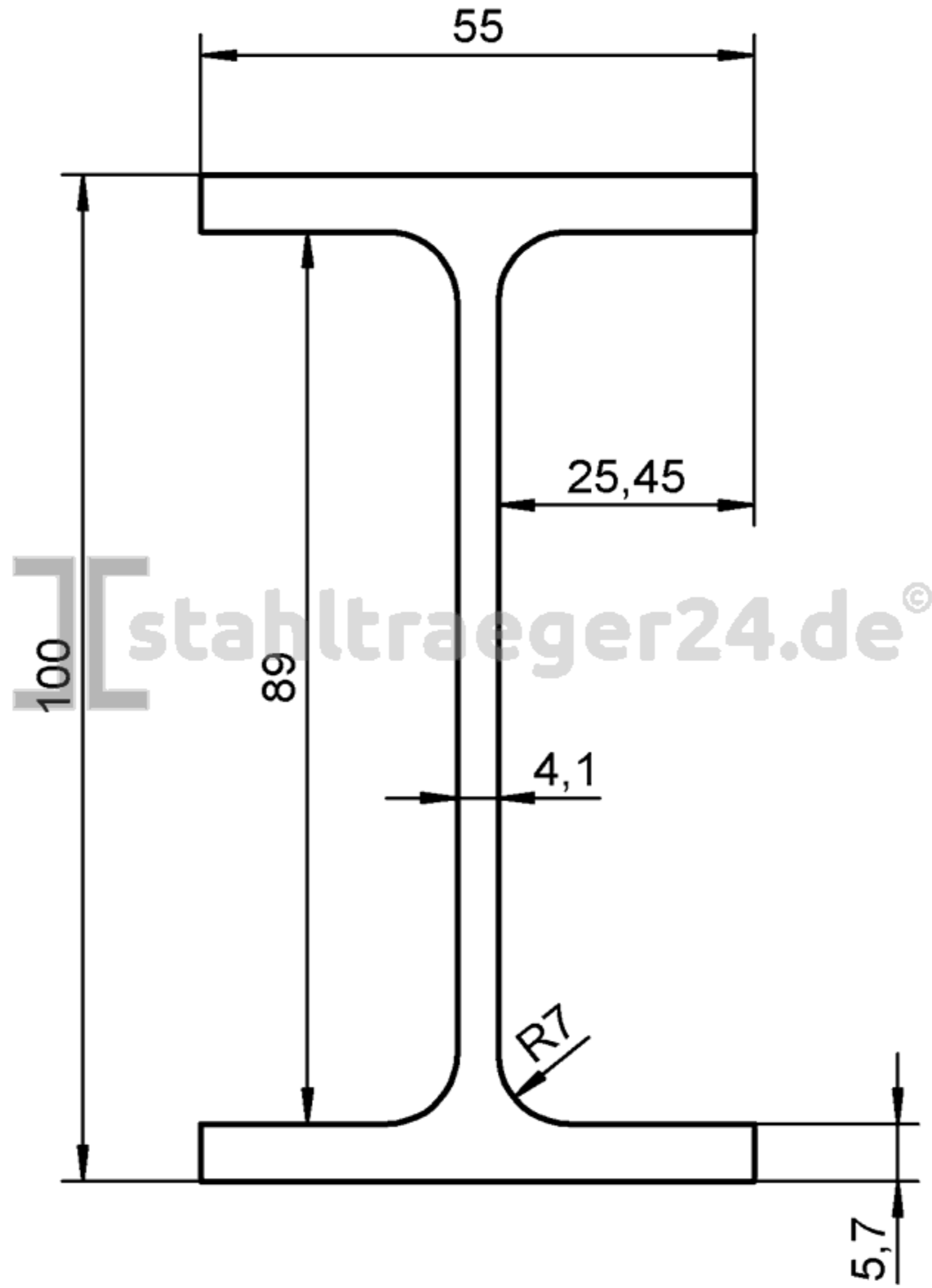

8,3 kg/m