

IPE 140

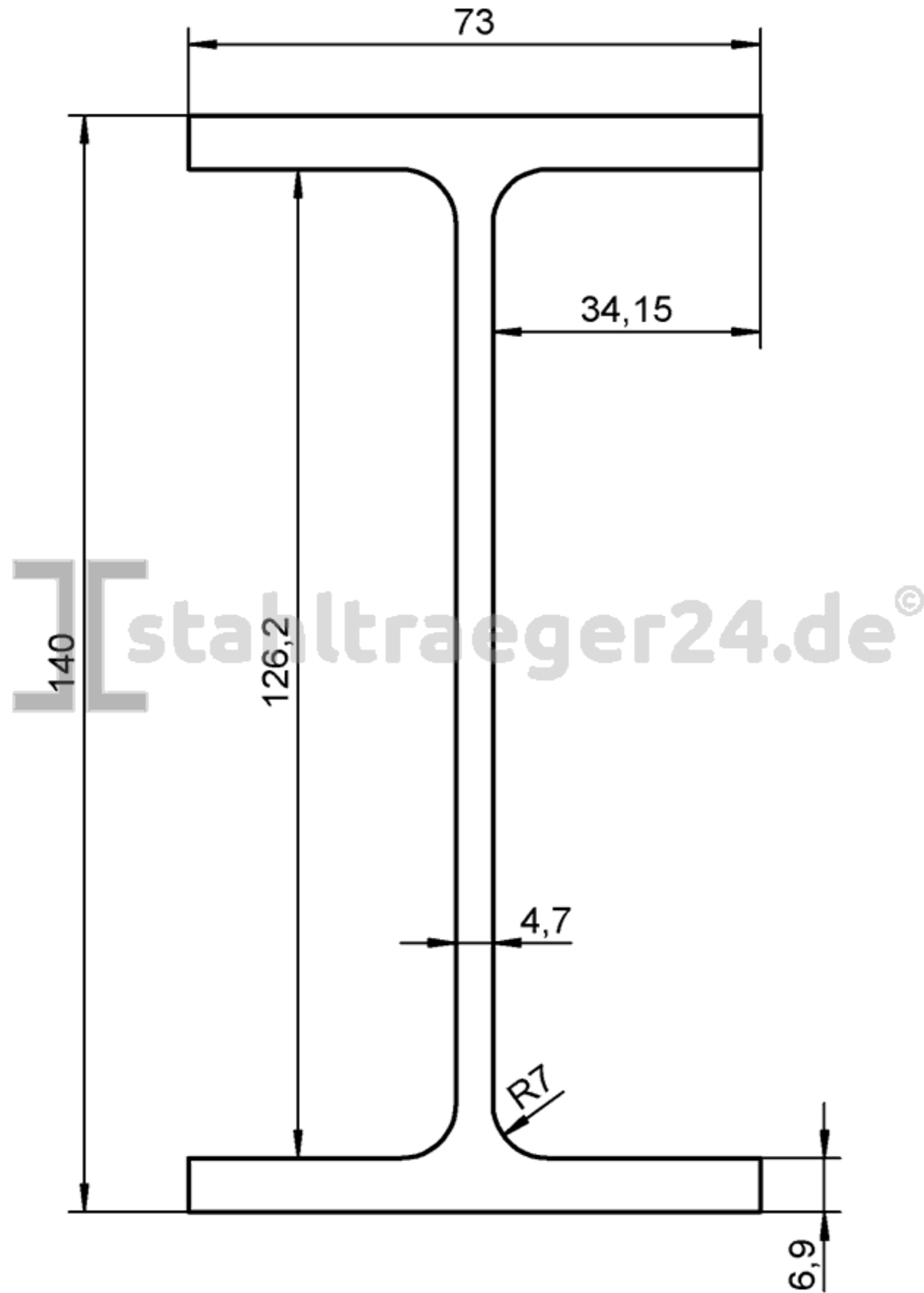

13,2 kg/m