

IPE 160

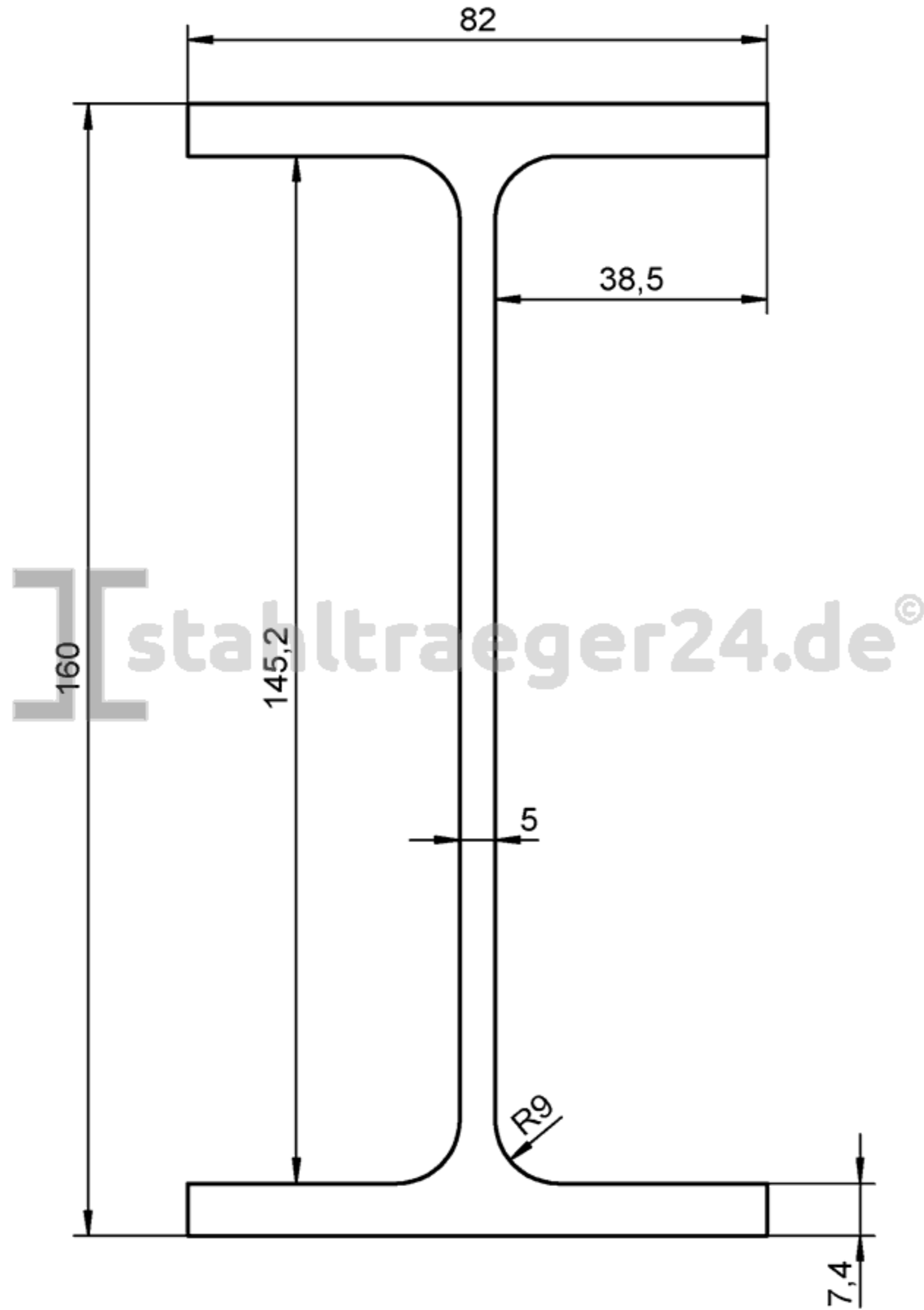

16,2 kg/m