

IPE 200

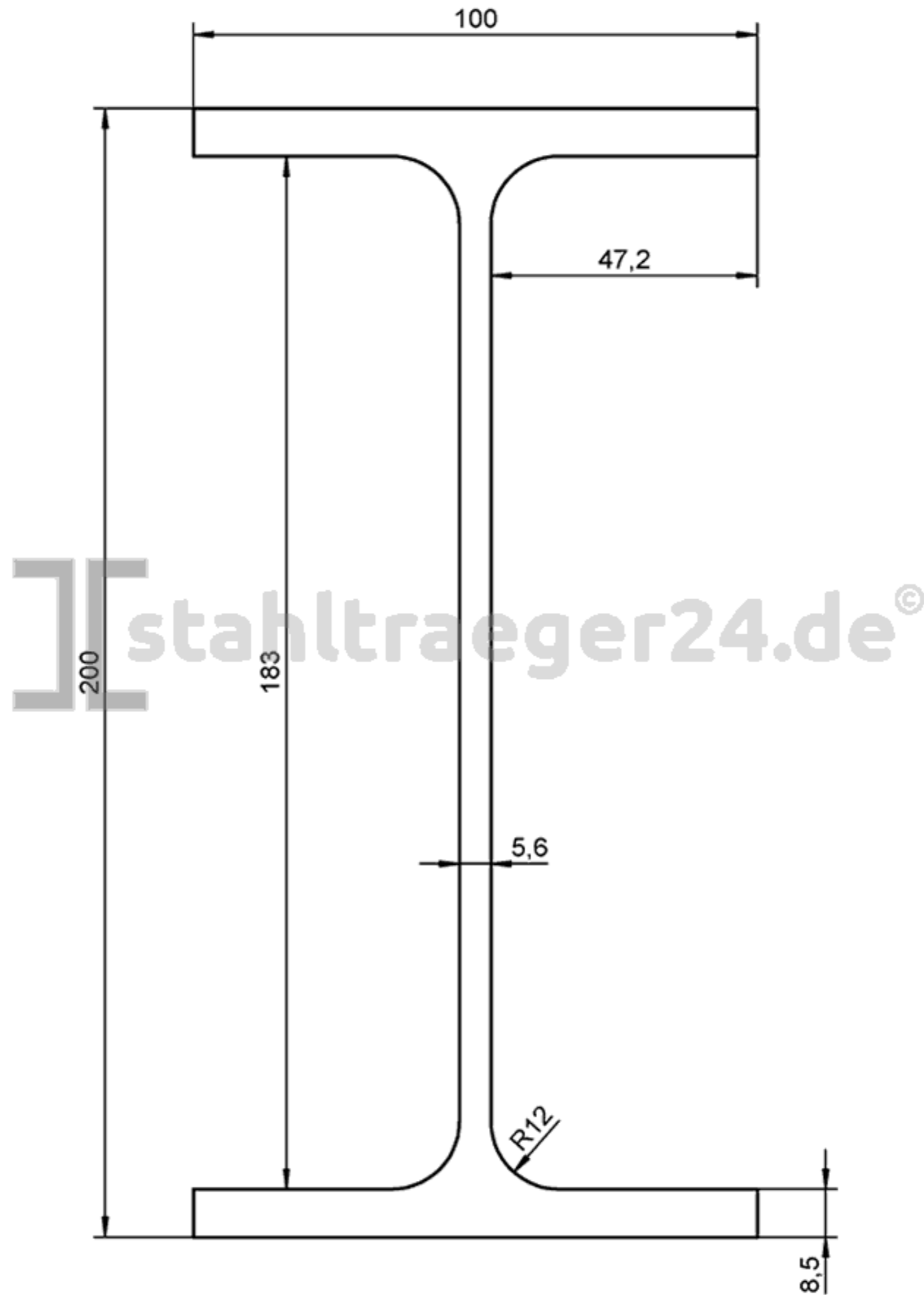

23,0 kg/m