

IPE 220

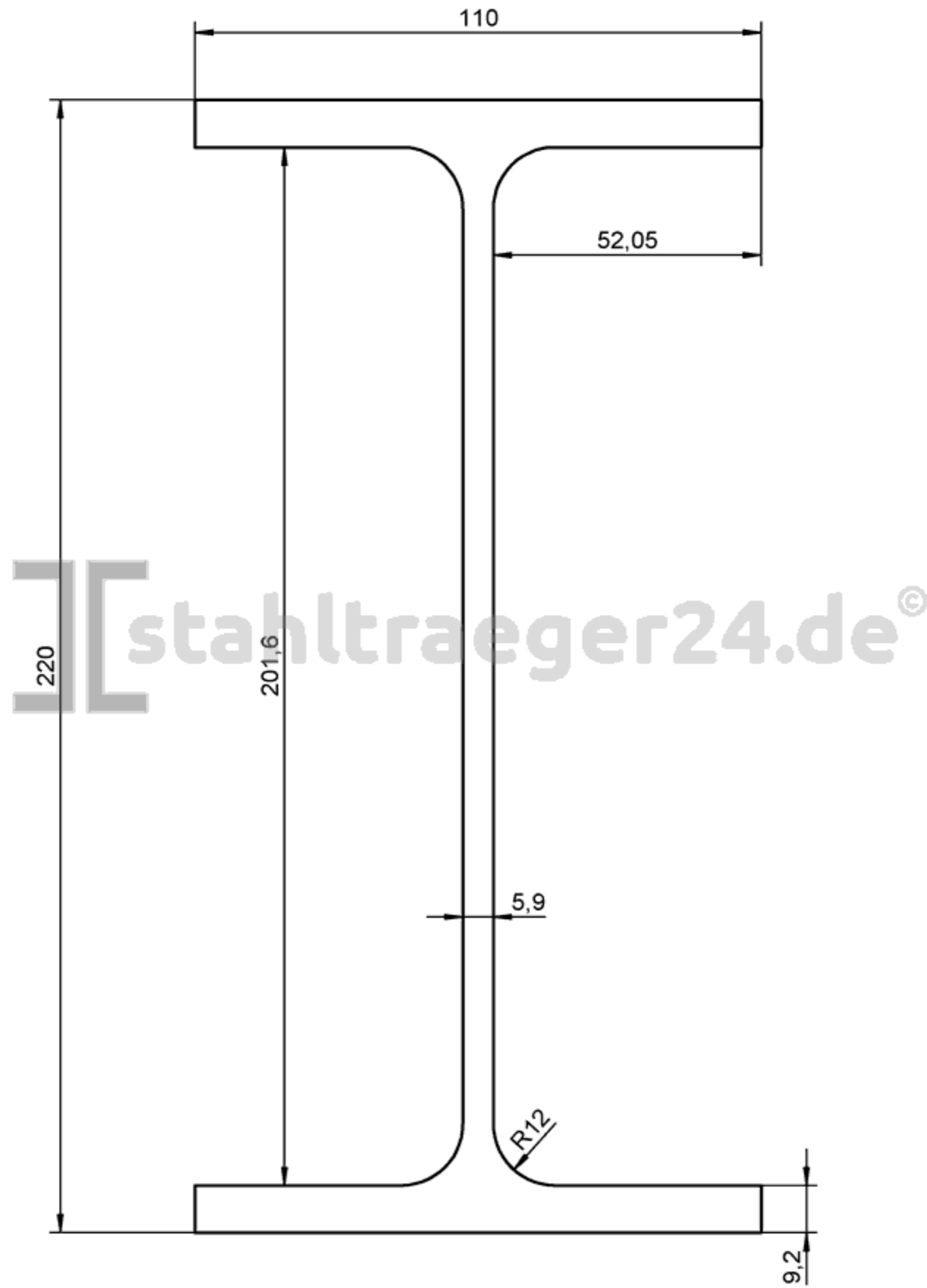

26,9 kg/m