

# UNP 140

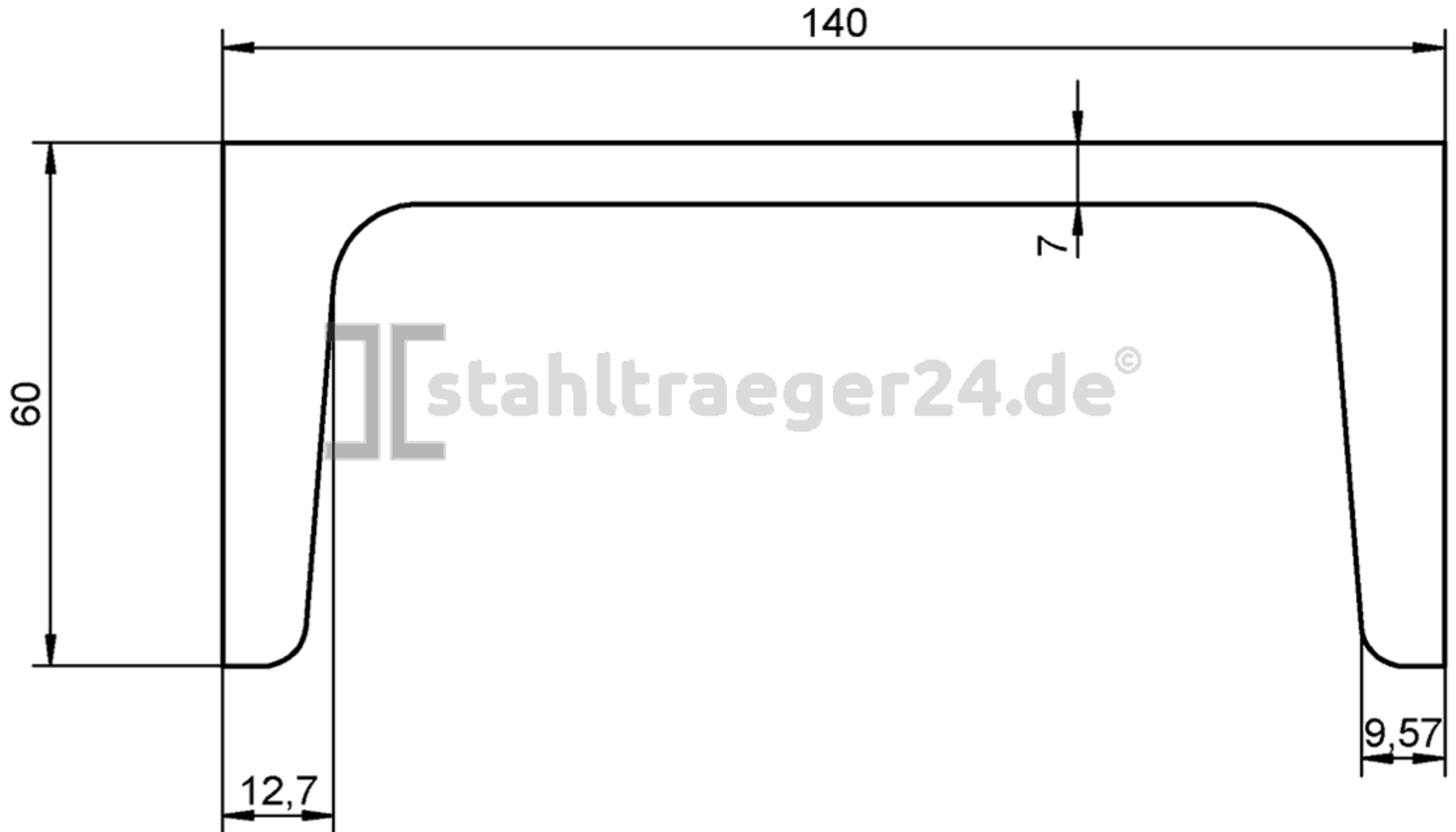

16,4 kg/m